

REVISIONS

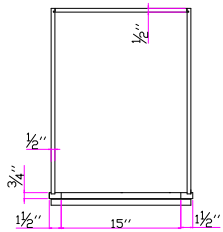

**SNS
SNW**

B09-FH

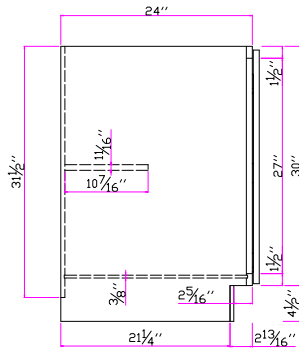
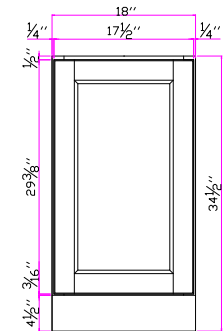

REVISIONS



**SNS
SNW**

B18-FH

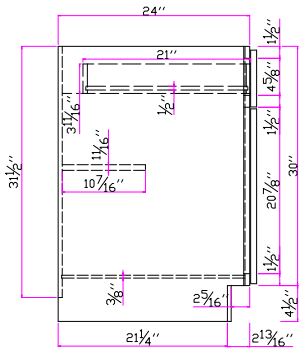
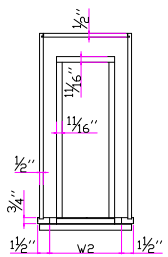
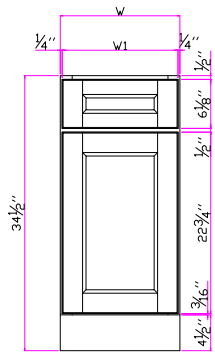

REVISIONS



**SNS
SNW**

B12-B21

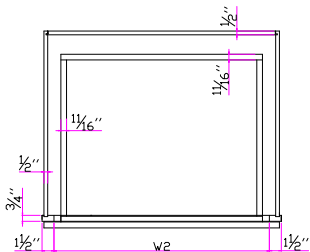
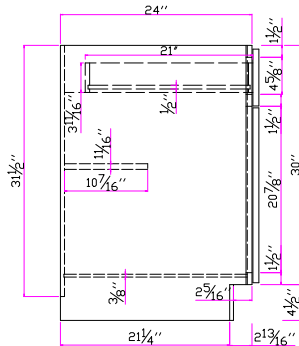
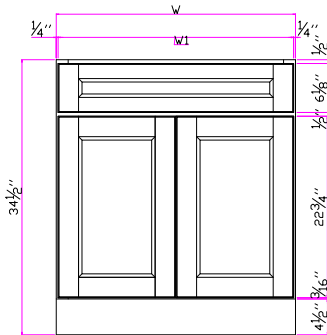

REVISIONS



**SNS
SNW**

B24-B30

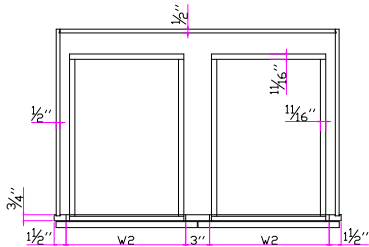
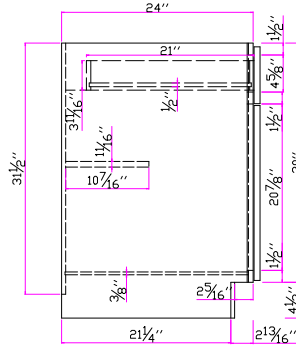
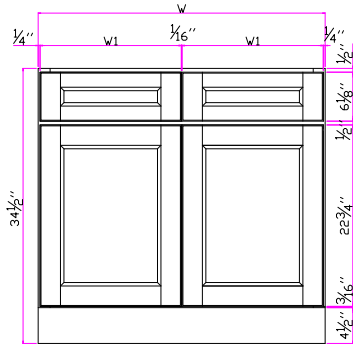

REVISIONS



**SNS
SNW**

B33-B36

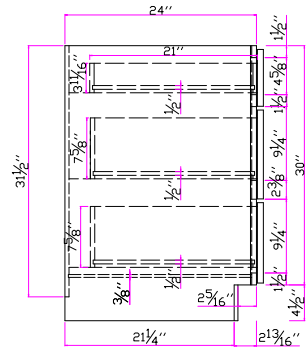
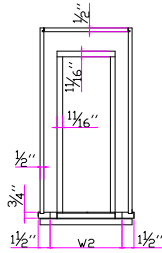
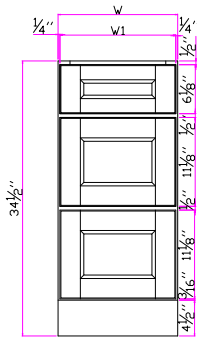

REVISIONS



**SNS
SNW**

DB15-DB30

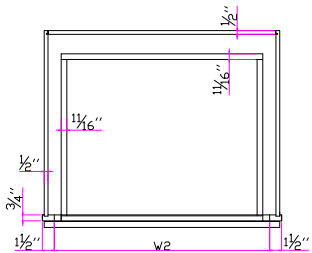
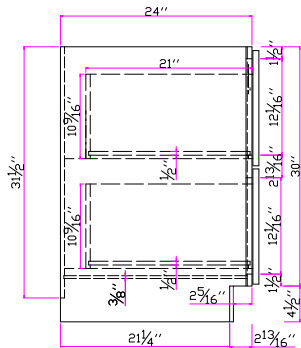
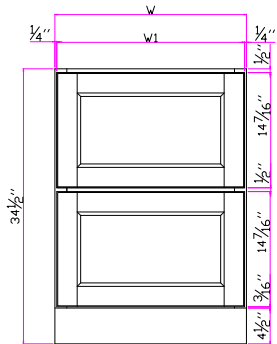

REVISIONS

GHI

**SNS
SNW**

**DB24-2
DB30-2**

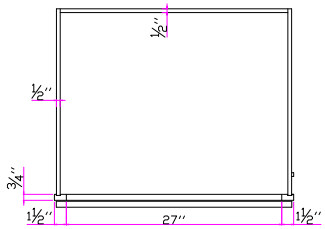
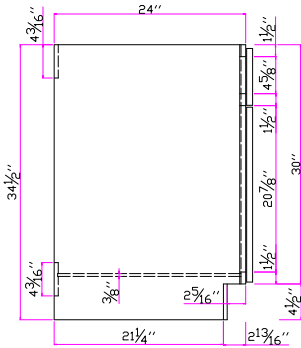
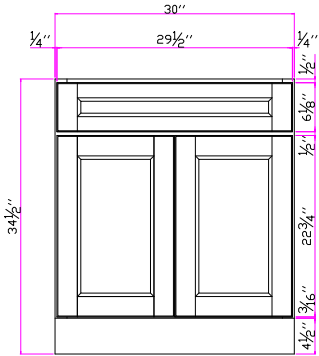

REVISIONS



**SNS
SNW**

SB30

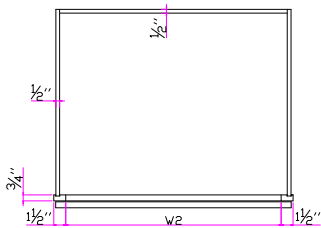
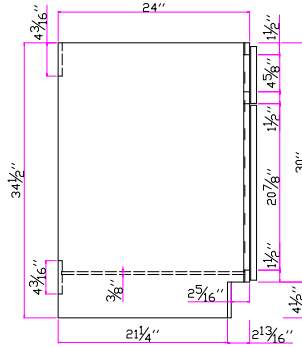
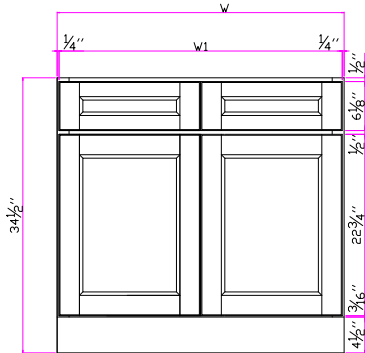

REVISIONS



**SNS
SNW**

SB33-SB42

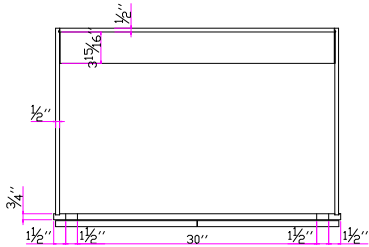
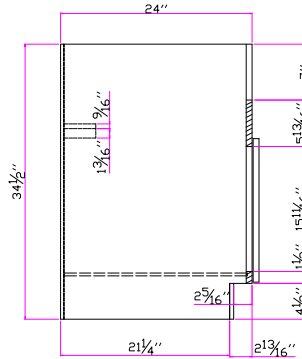
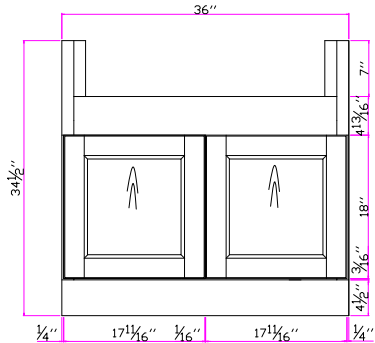

REVISIONS



**SNS
SNW**

FSB36

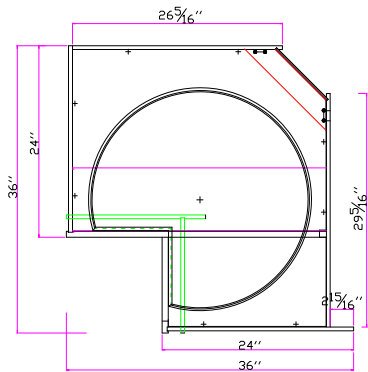
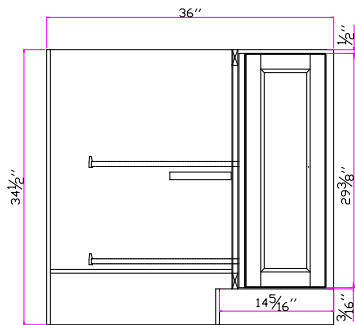

REVISIONS

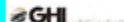

**SNS
SNW**

DCB3612

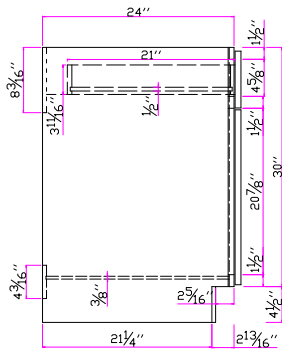
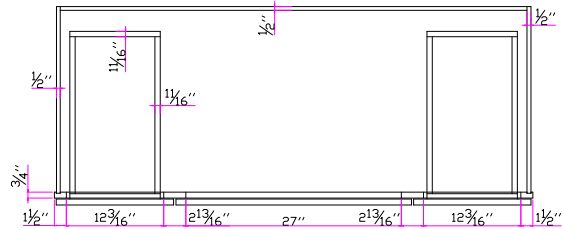
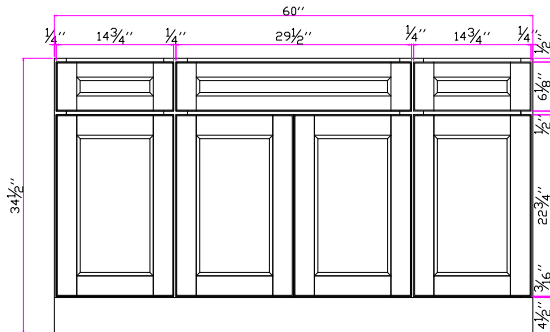

REVISIONS



**SNS
SNW**

SB60

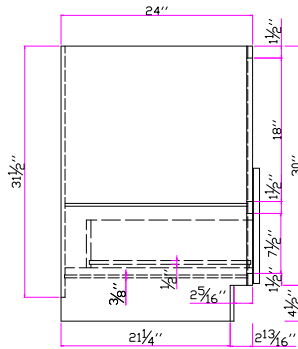
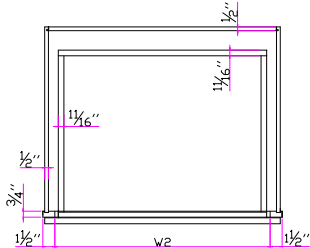
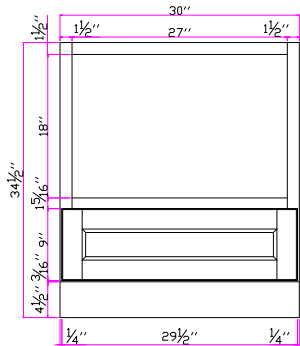

REVISIONS

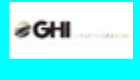

**SNS
SNW**

MB30

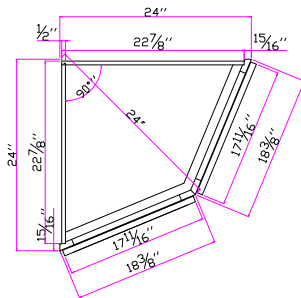
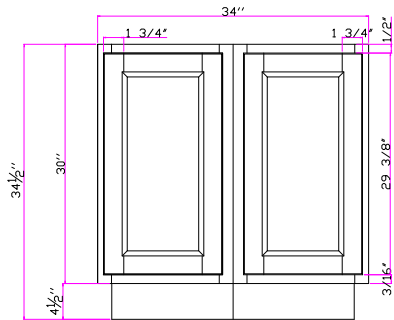

REVISIONS



**SNS
SNW**

BC24

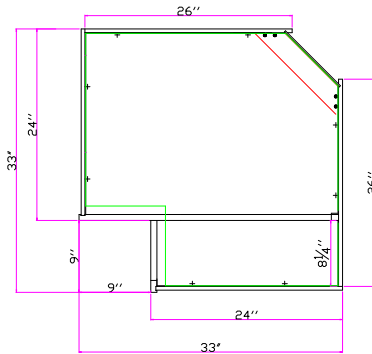
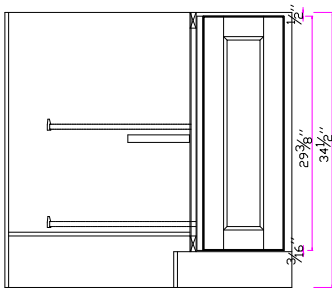

REVISIONS



**SNS
SNW**

ER3309

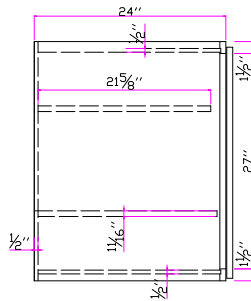
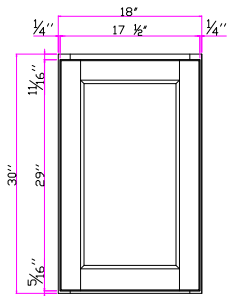

REVISIONS



**SNS
SNW**

W183024

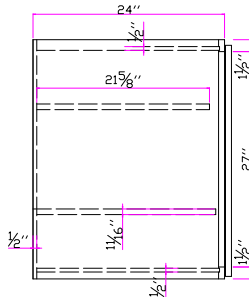
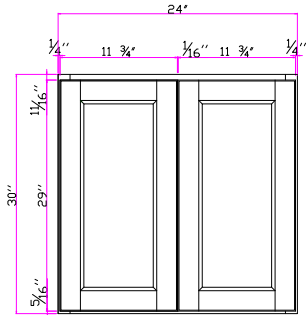

REVISIONS



**SNS
SNW**

W243024

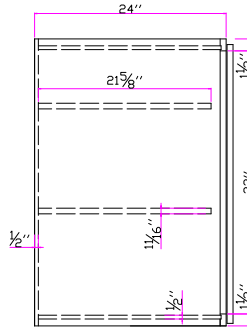
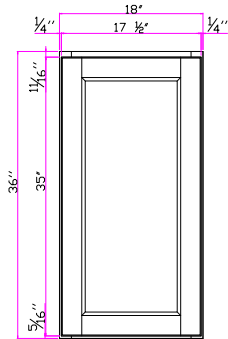

REVISIONS



**SNS
SNW**

W183624

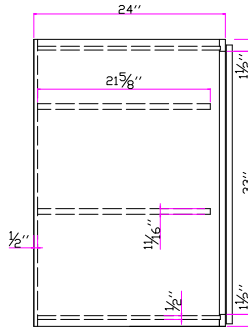
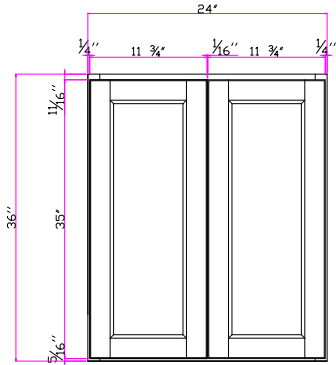

REVISIONS



**SNS
SNW**

W243624

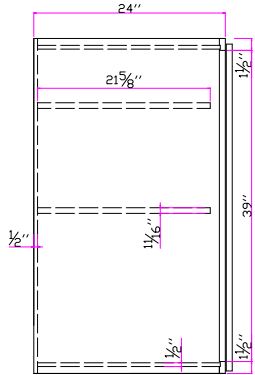
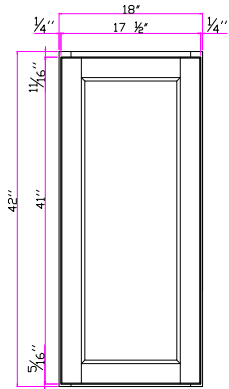

REVISIONS



**SNS
SNW**

W184224

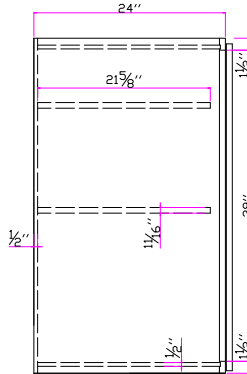
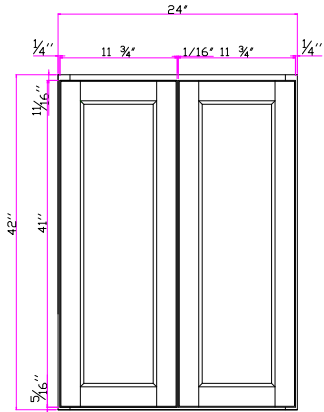

REVISIONS



**SNS
SNW**

W244224

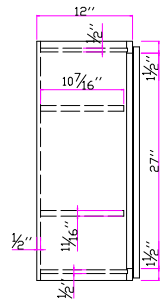
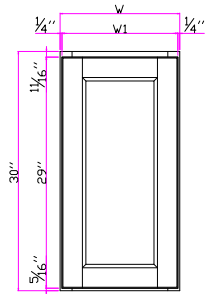

REVISIONS



**SNS
SNW**

W0930-W2130

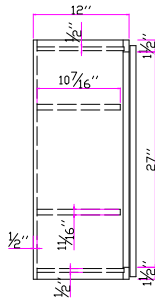
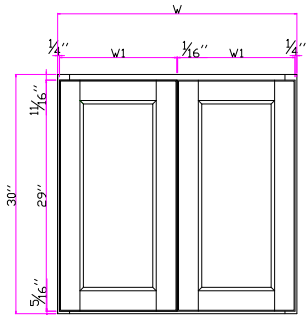

REVISIONS

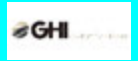

**SNS
SNW**

W2430-W3630

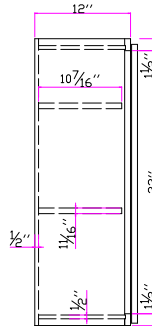
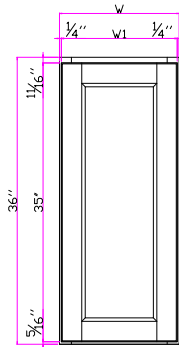

REVISIONS



**SNS
SNW**

W0936-2136

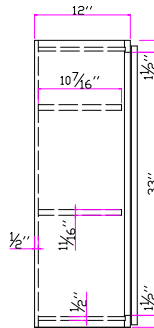
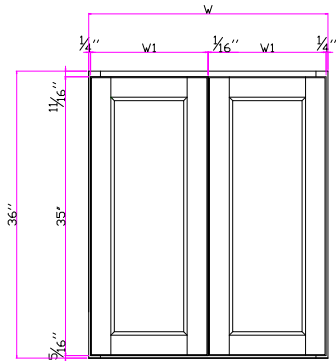

REVISIONS



**SNS
SNW**

W2436-W3636

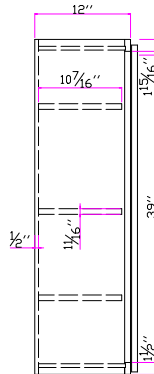
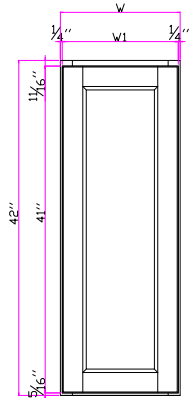

REVISIONS



**SNS
SNW**

W0942-W2142

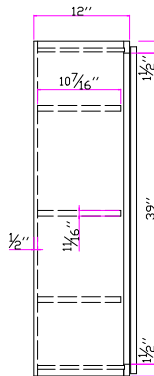
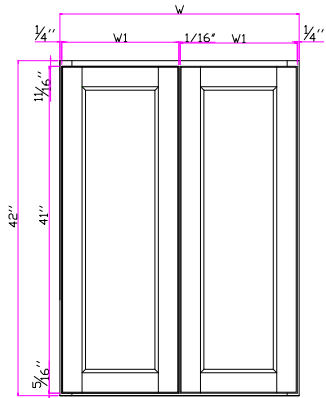

REVISIONS



**SNS
SNW**

W2442-W3642

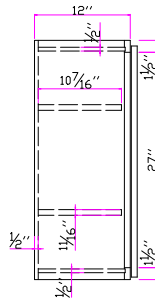
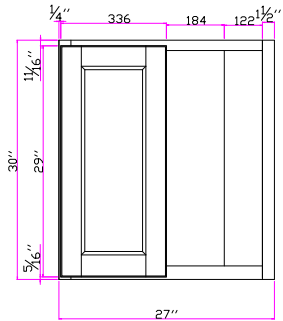

REVISIONS



**SNS
SNW**

WBC2730

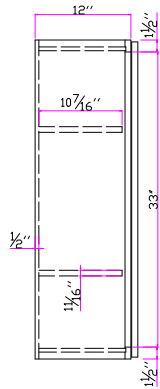
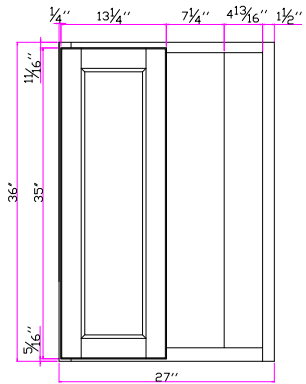

REVISIONS



**SNS
SNW**

WBC2736

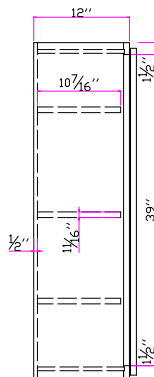
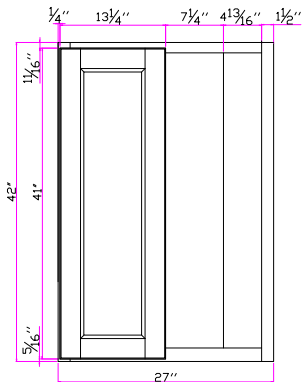

REVISIONS



**SNS
SNW**

WBC2742

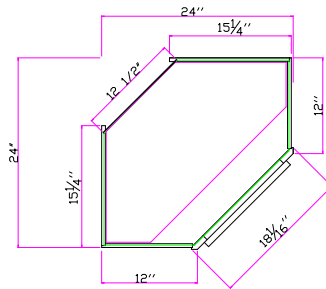
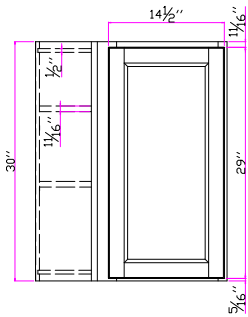

REVISIONS



**SNS
SNW**

WDC2430

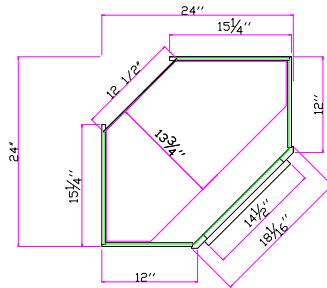
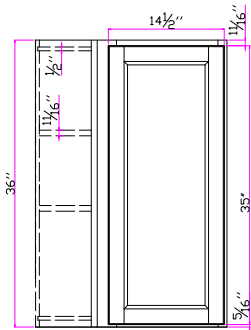

REVISIONS



**SNS
SNW**

WDC2436

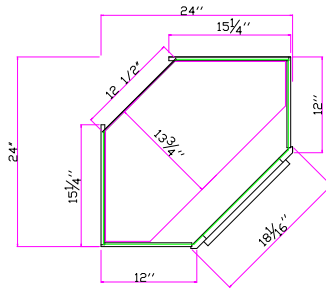
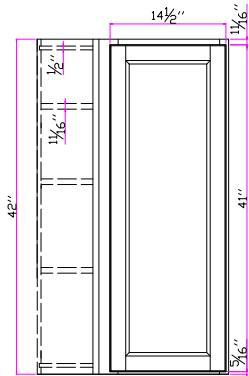

REVISIONS



**SNS
SNW**

WDC2442

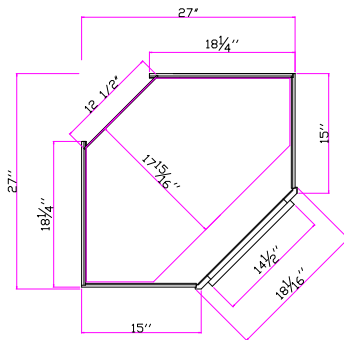
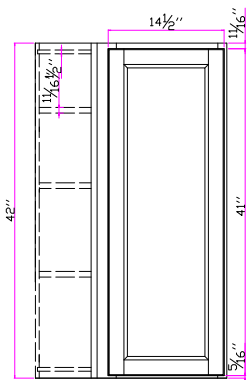

REVISIONS



**SNS
SNW**

WDC2742

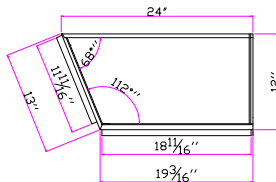
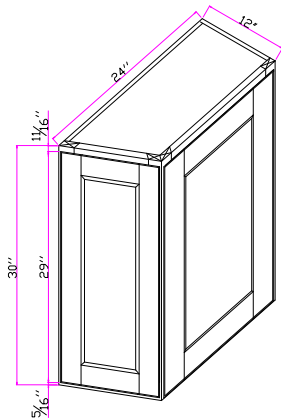

REVISIONS



**SNS
SNW**

WAC2430

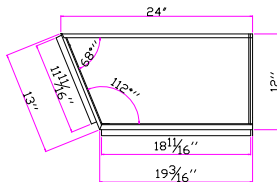
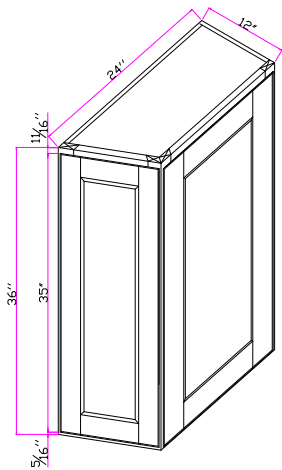

REVISIONS



**SNS
SNW**

WAC2436

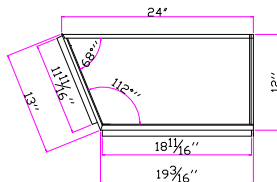
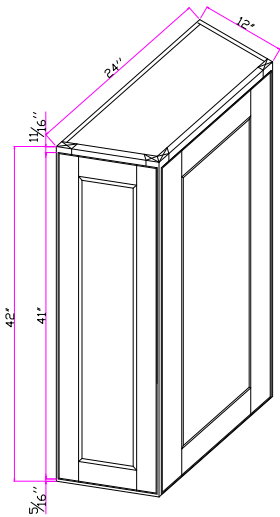

REVISIONS



**SNS
SNW**

WAC2442

REVISIONS

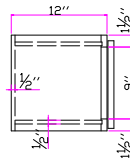
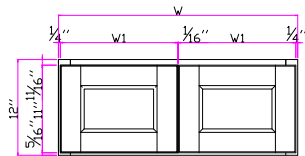

**SNS
SNW**

W3012-W3612

REVISIONS

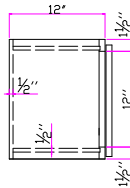
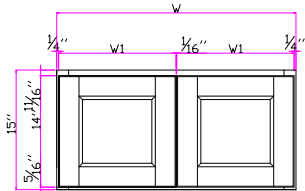

**SNS
SNW**

W2415-W3615

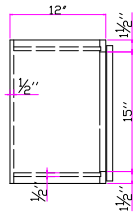
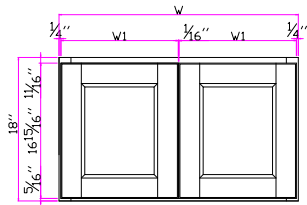

REVISIONS



**SNS
SNW**

W3018-W3618

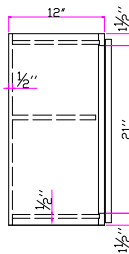
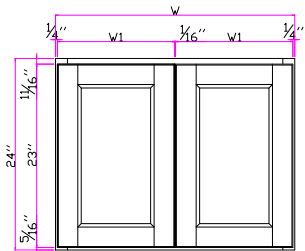

REVISIONS



**SNS
SNW**

W3024-W3624

REVISIONS

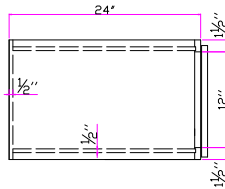
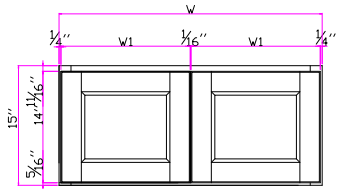

**SNS
SNW**

W331524
W361524

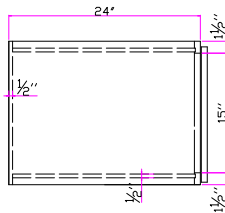
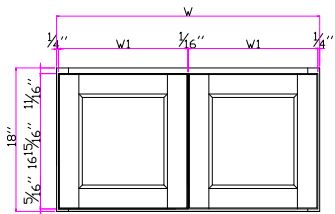

REVISIONS



**SNS
SNW**

**W331824
W361824**

REVISIONS

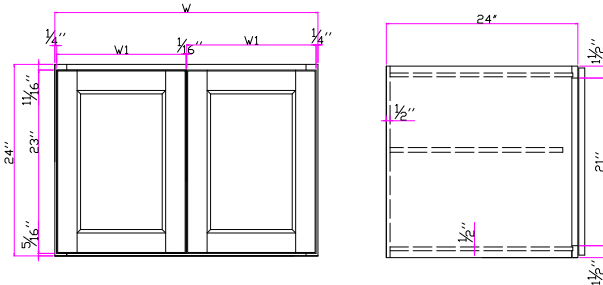

**SNS
SNW**

W332424
W362424

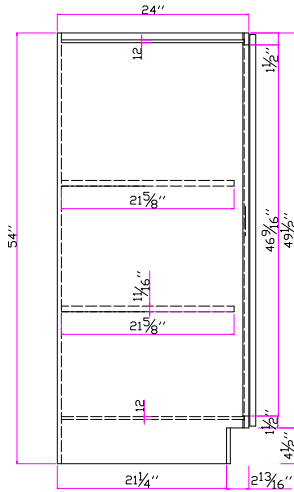
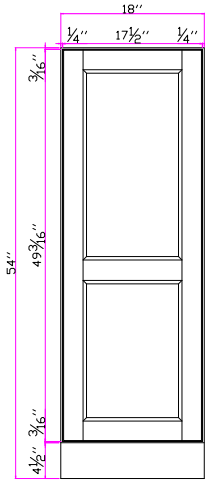

REVISIONS



**SNS
SNW**

UCB1854

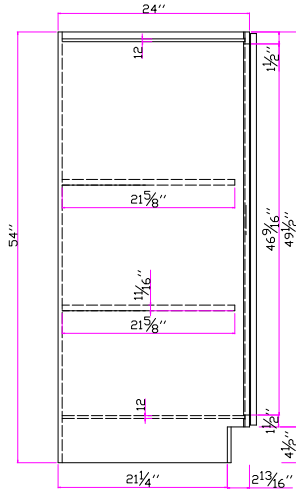
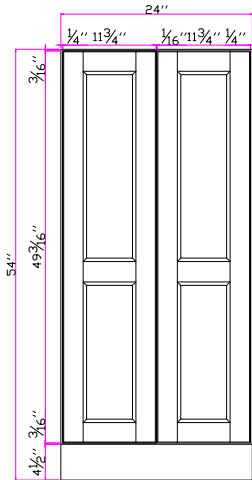

REVISIONS



**SNS
SNW**

UCB2454

REVISIONS



**SNS
SNW**

WR3015

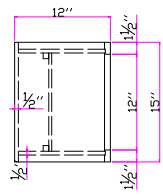
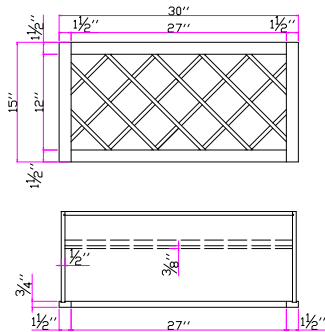

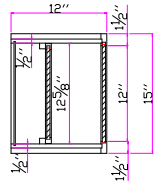
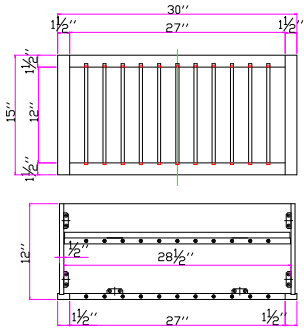

REVISIONS



**SNS
SNW**

PR3015

REVISIONS

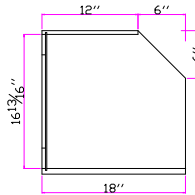
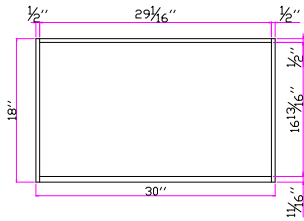

**SNS
SNW**

MC3018

REVISIONS

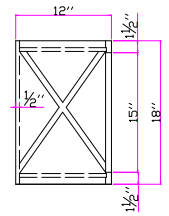
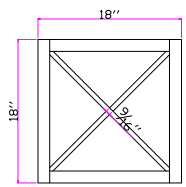

**SNS
SNW**

WR1818

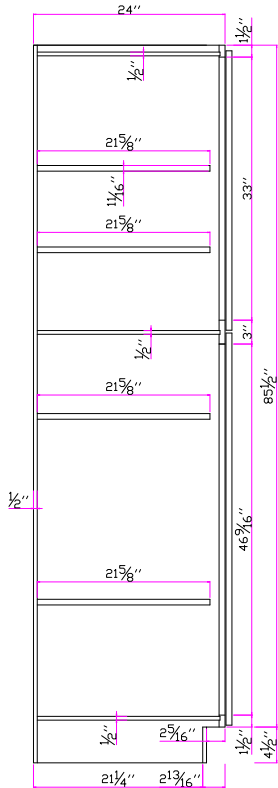
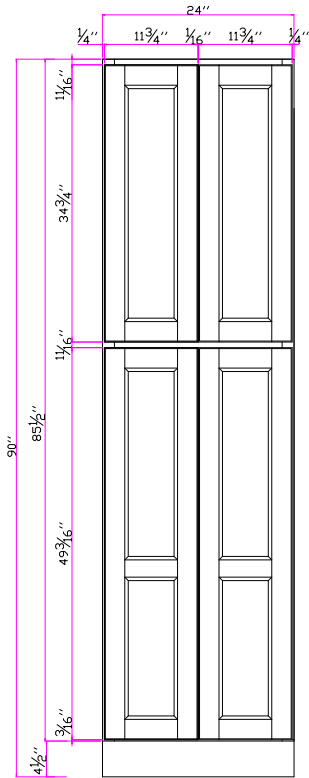

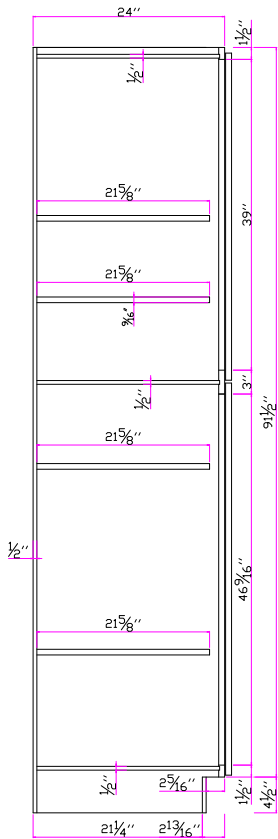
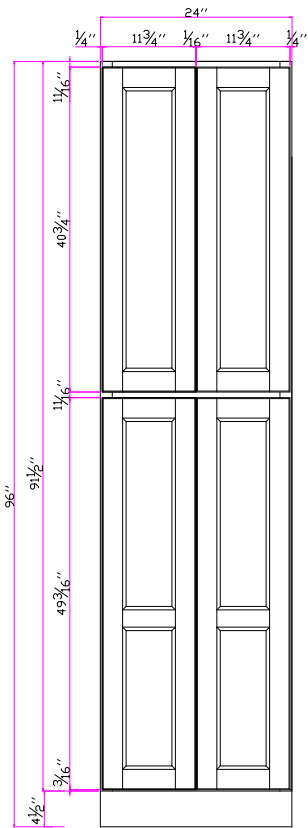

**SNS
SNW**

WP2496

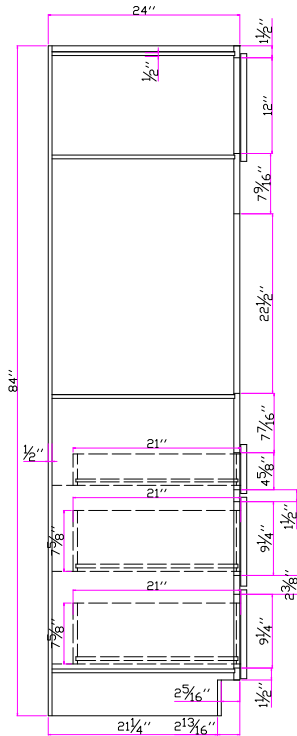
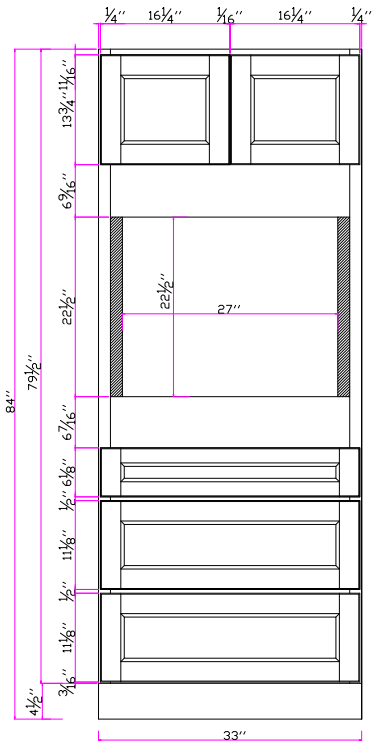

**SNS
SNW**

OU332484

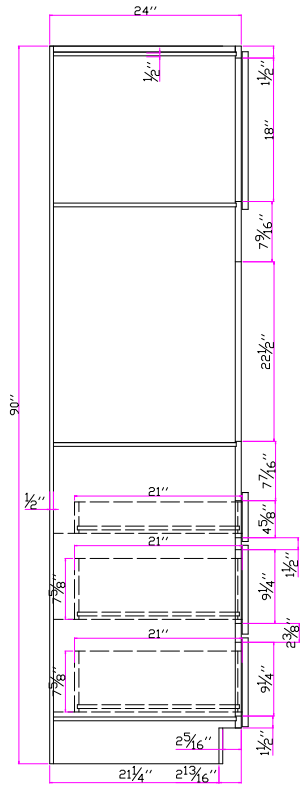
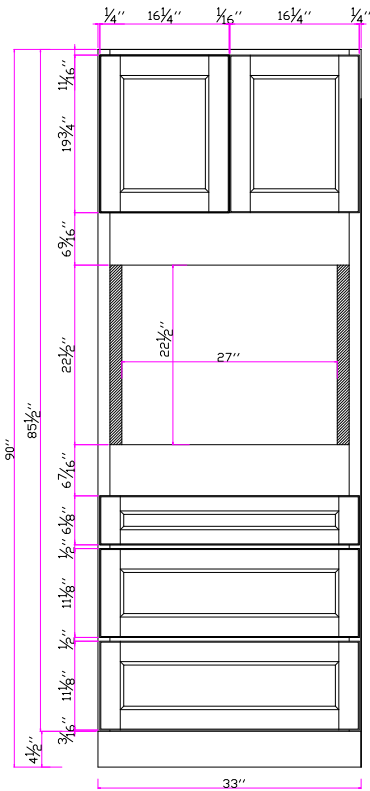

**SNS
SNW**

OU332490

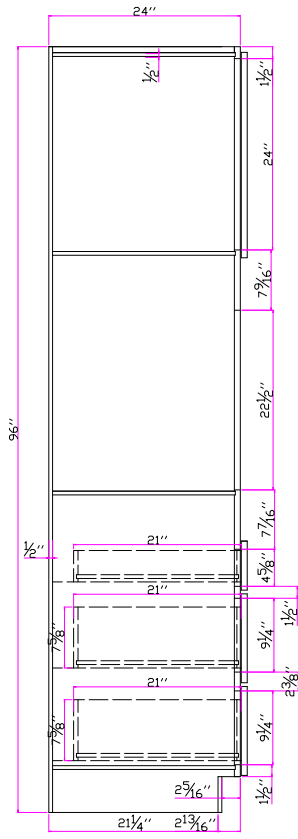
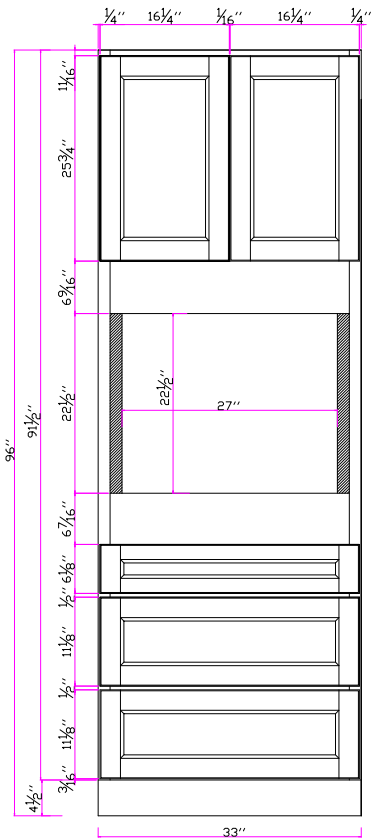

**SNS
SNW**

OU332496

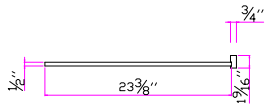
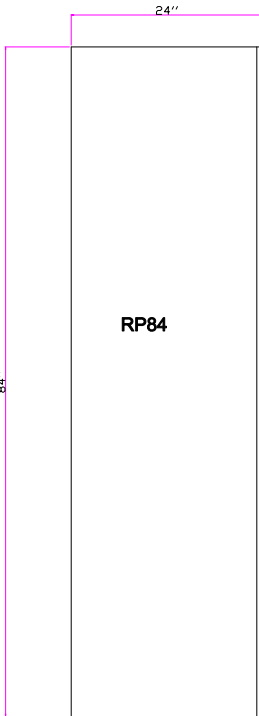

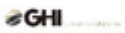
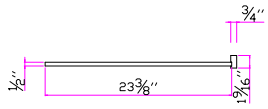
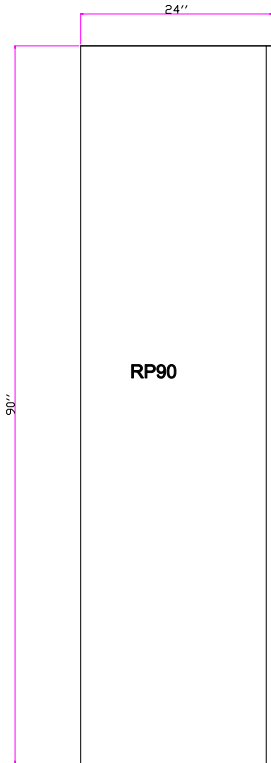

**SNS
SNW**

RP90

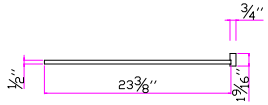
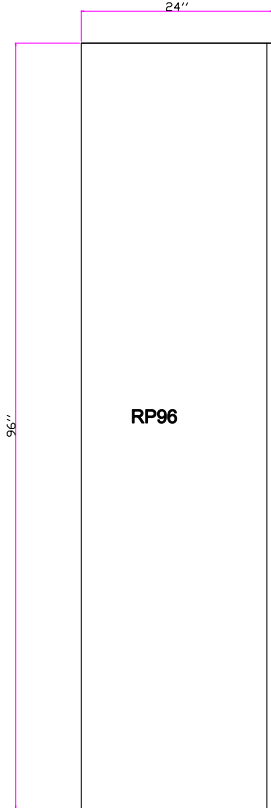

**SNS
SNW**

RP96

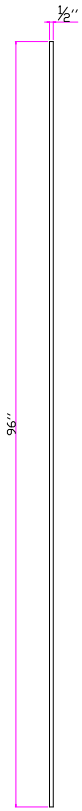
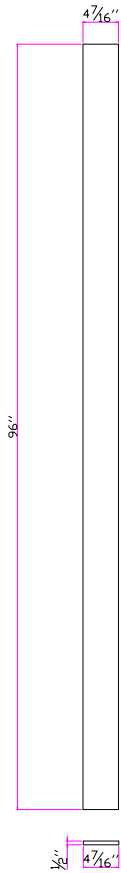

**SNS
SNW**

TK8

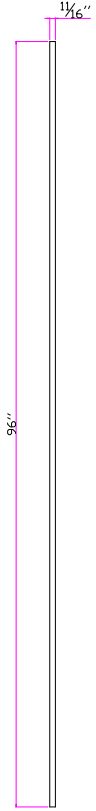
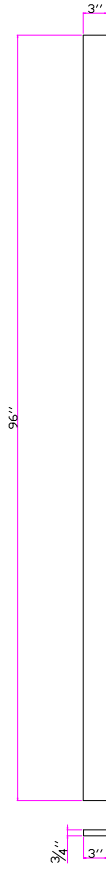

**SNS
SNW**

F396

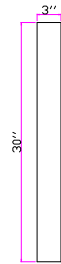

F330



F342

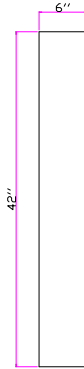

F642

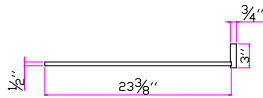
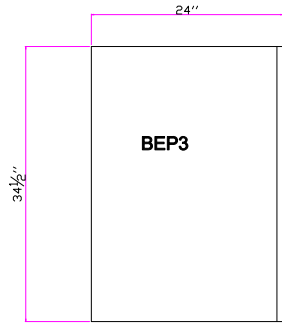

REVISIONS



**SNS
SNW**

BEP3

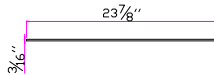
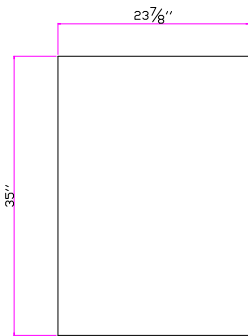

**SNS
SNW**

End Panel 24*35*3/16

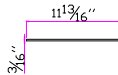
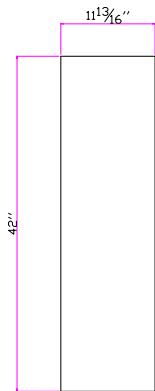

**SNS
SNW**

Wall End Panel 12*42*3/16

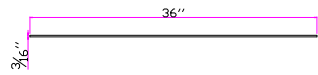
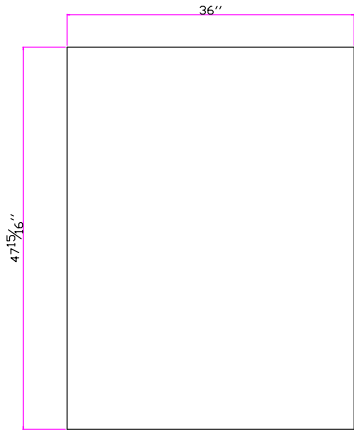

**SNS
SNW**

Island Panel 3' *4' *1/4

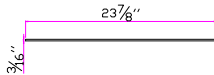
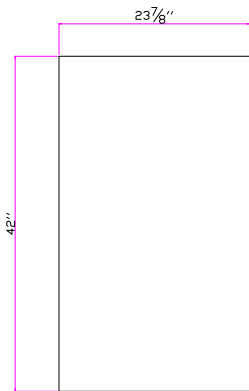

**SNS
SNW**

Skin Panel 24" * 42" * 1/4"

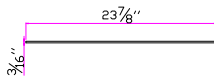
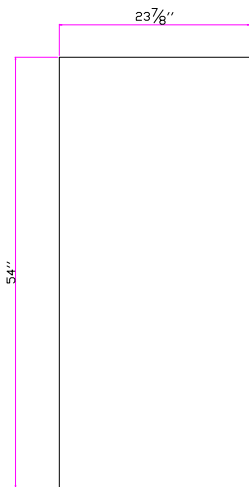

**SNS
SNW**

Skin Panel 24"*54"*1/4"

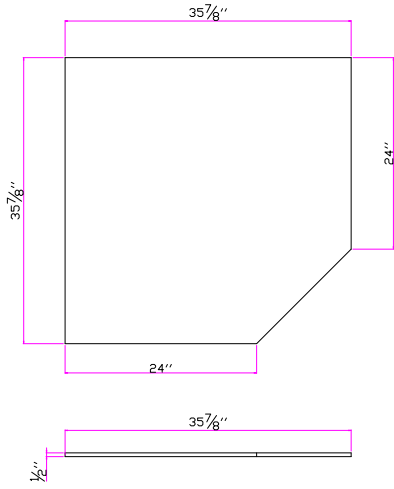

**SNS
SNW**

CSF-FLOOR-NM

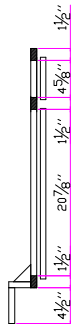
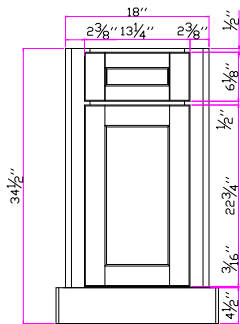

REVISIONS



**SNS
SNW**

CSF36

REVISIONS



**SNS
SNW**

SGH30

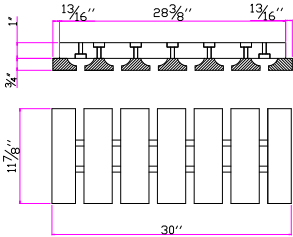

REVISIONS



**SNS
SNW**

LRM7

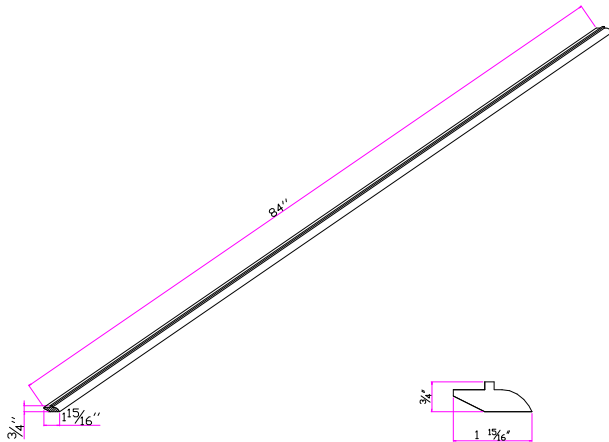

REVISIONS

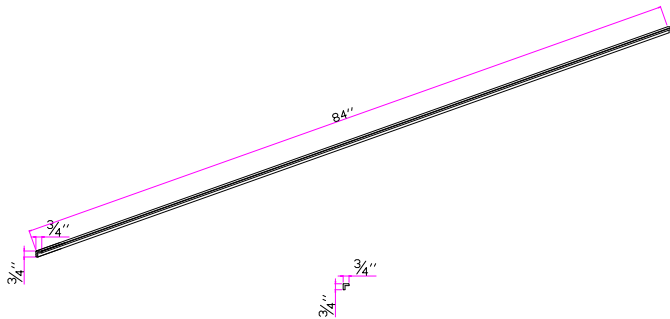

**SNS
SNW**

OSC7

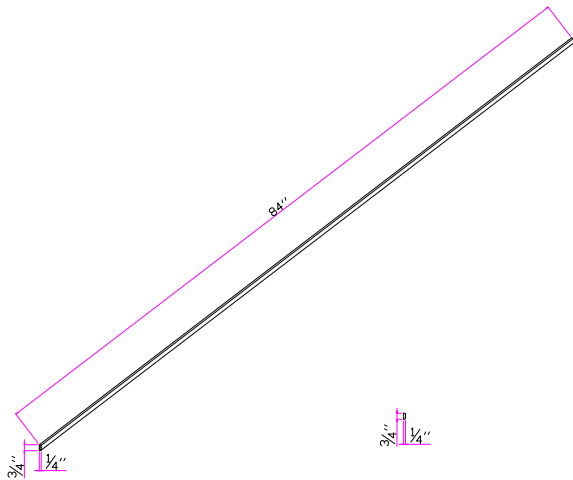

REVISIONS



**SNS
SNW**

SCM7

REVISIONS



**SNS
SNW**

VAR48

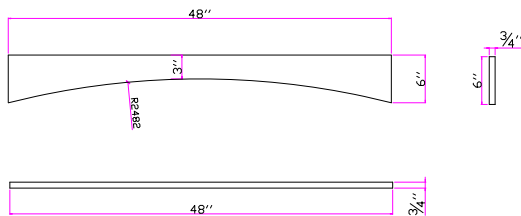

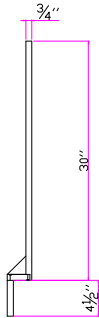
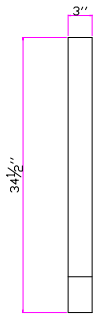

REVISIONS



**SNS
SNW**

BF3

REVISIONS



**SNS
SNW**

CM8

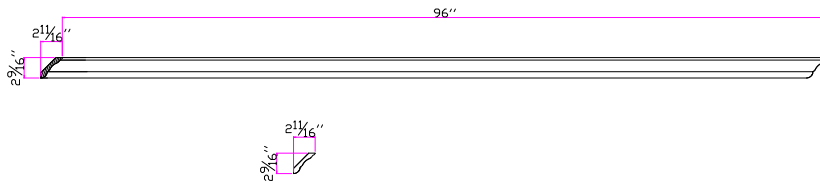

REVISIONS



**SNS
SNW**

SM8

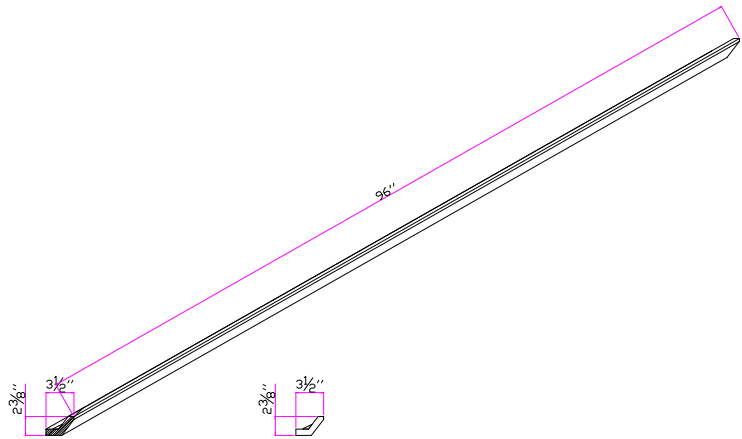

REVISIONS



**SNS
SNW**

FBM8

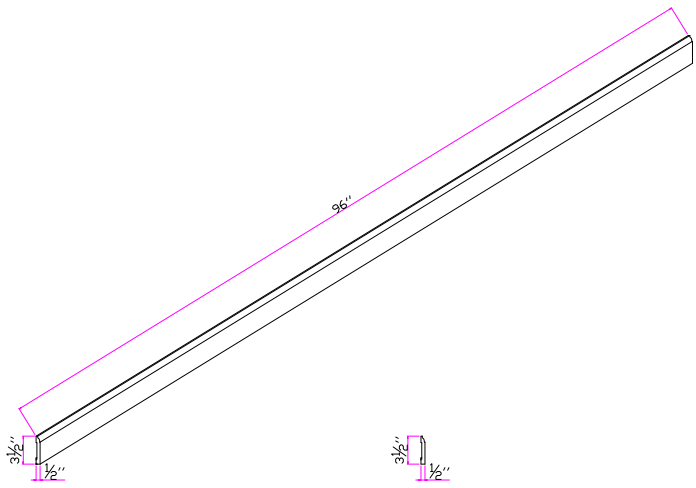

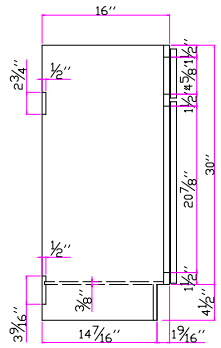
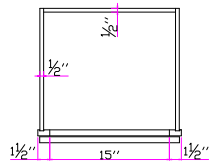
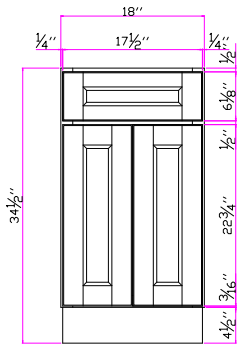

REVISIONS



**SNS
SNW**

V1816

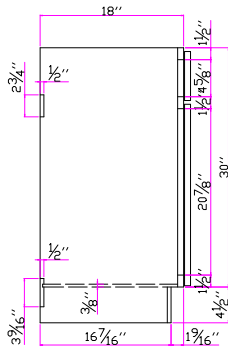
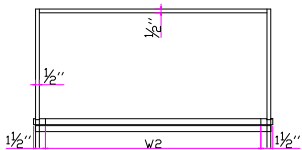
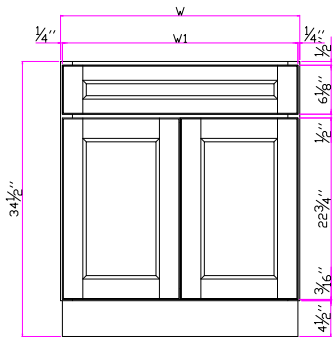

REVISIONS



**SNS
SNW**

V2418
V3018
V3618

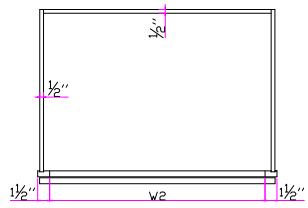
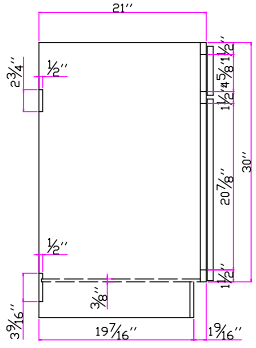
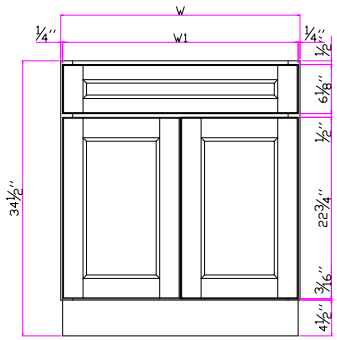

REVISIONS



**SNS
SNW**

V2421
V3021
V3621

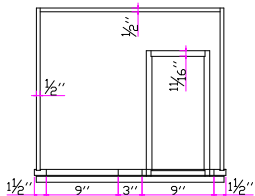
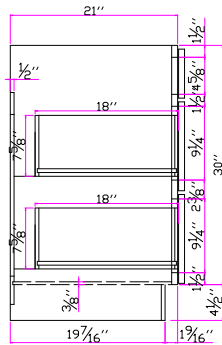
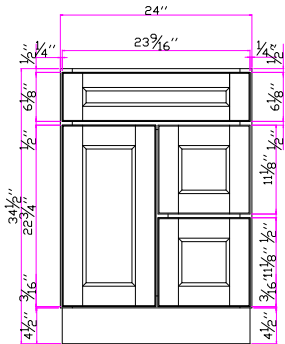

REVISIONS



**SNS
SNW**

V2421D

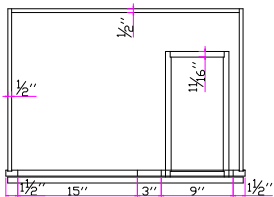
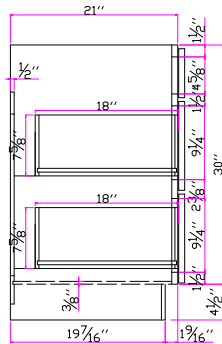
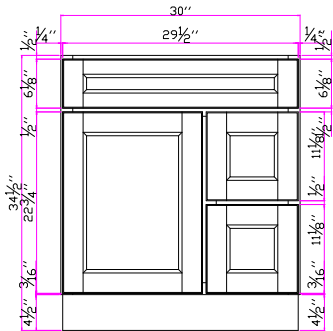

REVISIONS



SNS
SNW

V3021D

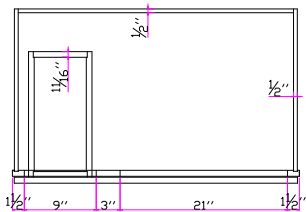
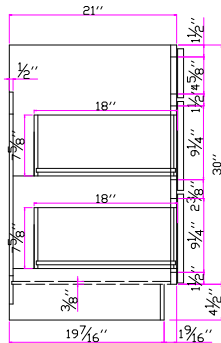
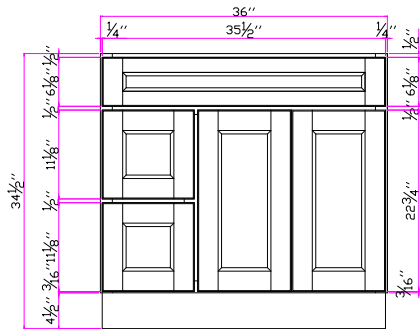

REVISIONS

GHI

**SNS
SNW**

V3621D-L

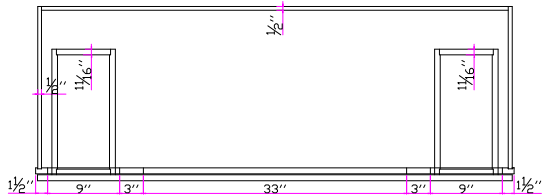
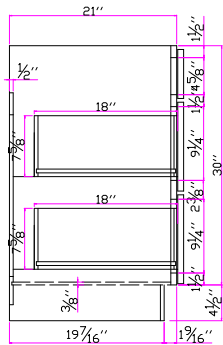

REVISIONS



**SNS
SNW**

V6021D

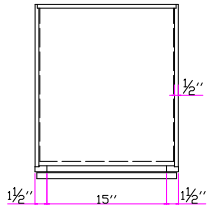
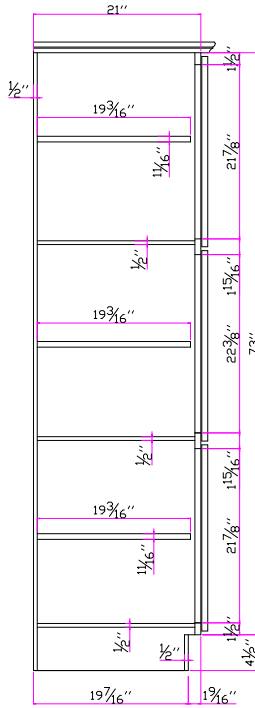
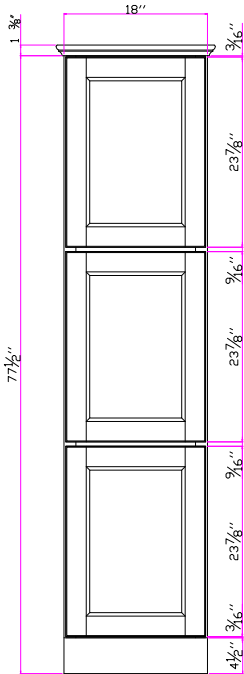

**SNS
SNW**

L781821

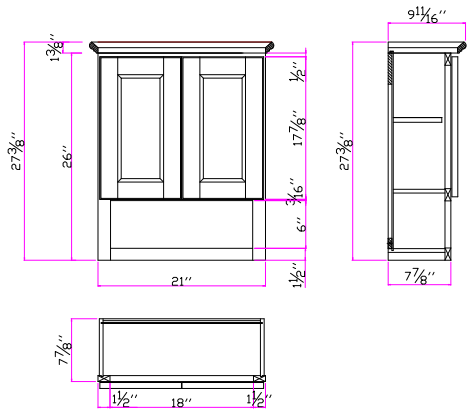

REVISIONS



**SNS
SNW**

BV2126

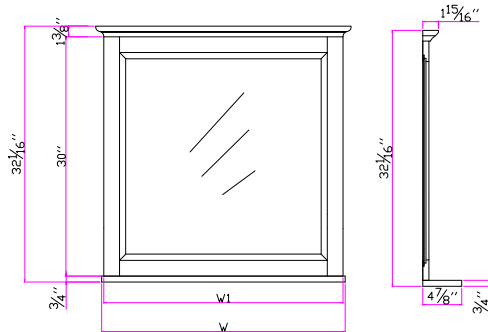

REVISIONS



**SNS
SNW**

**M3030
M3630**